

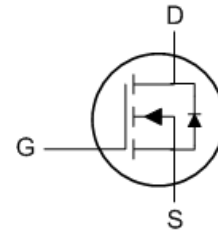

### Features

- Split Gate Trench MOSFET technology
- Excellent package for heat dissipation
- High density cell design for low  $R_{DS(ON)}$



### Applications

- DC-DC Converters
- Power management functions
- Synchronous-rectification applications

### PDFN5060-8L Pin Configuration

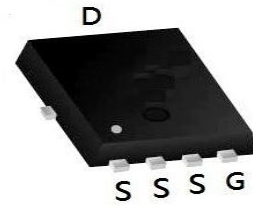

### Product Summary

<b>BVDSS</b>	<b>RDSON</b>	<b>ID</b>
100V	4.5mΩ	100A

### Absolute Maximum Ratings (T<sub>c</sub> = 25°C, unless otherwise noted)

Parameter		Symbol	Value	Unit
Drain-Source Voltage		<b>V<sub>DS</sub></b>	100	V
Gate-Source Voltage		<b>V<sub>GS</sub></b>	±20	V
Continuous Drain Current	T <sub>c</sub> =25°C	<b>I<sub>D</sub></b>	100	A
	T <sub>c</sub> =100°C		60	
Pulsed Drain Current <sup>4</sup>		<b>I<sub>DM</sub></b>	380	A
Single Pulse Avalanche Energy <sup>3</sup>		<b>EAS</b>	205	mJ
Total Power Dissipation	T <sub>c</sub> =25°C	<b>P<sub>D</sub></b>	113.6	W
Operating Junction and Storage Temperature Range		<b>T<sub>J</sub>, T<sub>STG</sub></b>	-55 to 150	°C

### Thermal Characteristics

Parameter	Symbol	Value	Unit
Thermal Resistance from Junction-to-Ambient <sup>1</sup>	<b>R<sub>θJA</sub></b>	58	°C/W
Thermal Resistance from Junction-to-Case	<b>R<sub>θJC</sub></b>	1.1	°C/W



### Electrical Characteristics (T<sub>J</sub> = 25°C, unless otherwise noted)

Parameter	Symbol	Test Conditions	Min.	Typ.	Max.	Unit	
<b>Static Characteristics</b>							
Drain-Source Breakdown Voltage	V <sub>(BR)DSS</sub>	V <sub>GS</sub> = 0V, I <sub>D</sub> = 250μA	100	-	-	V	
Gate-body Leakage current	I <sub>GSS</sub>	V <sub>DS</sub> = 0V, V <sub>GS</sub> = ±20V	-	-	±100	nA	
Zero Gate Voltage Drain Current	I <sub>DSS</sub>	V <sub>DS</sub> = 100V, V <sub>GS</sub> = 0V	T <sub>J</sub> = 25°C	-	-	1	μA
			T <sub>J</sub> = 100°C	-	-	100	
Gate-Threshold Voltage	V <sub>GS(th)</sub>	V <sub>DS</sub> = V <sub>GS</sub> , I <sub>D</sub> = 250μA	1.2	1.8	2.5	V	
Drain-Source on-Resistance <sup>2</sup>	R <sub>DS(on)</sub>	V <sub>GS</sub> = 10V, I <sub>D</sub> = 20A	-	4.5	6	mΩ	
		V <sub>GS</sub> = 4.5V, I <sub>D</sub> = 15A	-	6.6	9		
<b>Dynamic Characteristics</b>							
Input Capacitance	C <sub>iss</sub>	V <sub>DS</sub> = 50V, V <sub>GS</sub> = 0V, f = 1MHz	-	4400	-	pF	
Output Capacitance	C <sub>oss</sub>		-	645	-		
Reverse Transfer Capacitance	C <sub>rss</sub>		-	20	-		
<b>Switching Characteristics</b>							
Gate Resistance	R <sub>g</sub>	V <sub>GS</sub> = 0V, V <sub>DS</sub> = 0V, f = 1MHz	-	1.7	-	Ω	
Total Gate Charge	Q <sub>g</sub>	V <sub>GS</sub> = 10V, V <sub>DS</sub> = 50V, I <sub>D</sub> = 20A	-	75	-	nC	
Gate-Source Charge	Q <sub>gs</sub>		-	17	-		
Gate-Drain Charge	Q <sub>gd</sub>		-	13	-		
Turn-on Delay Time	t <sub>d(on)</sub>	V <sub>GS</sub> = 10V, V <sub>DS</sub> = 50V, R <sub>G</sub> = 3Ω, I <sub>D</sub> = 20A	-	15.4	-	ns	
Rise Time	t <sub>r</sub>		-	13	-		
Turn-off Delay Time	t <sub>d(off)</sub>		-	34	-		
Fall Time	t <sub>f</sub>		-	6.2	-		
<b>Drain-Source Body Diode Characteristics</b>							
Diode Forward Voltage <sup>2</sup>	V <sub>SD</sub>	I <sub>F</sub> = 20A, V <sub>GS</sub> = 0V	-	-	1.2	V	
Continuous Source Current <sup>1,5</sup>	I <sub>S</sub>	V <sub>G</sub> = V <sub>D</sub> = 0V, Force Current	-	-	95	A	
Body Diode Reverse Recovery Time	t <sub>rr</sub>	I <sub>F</sub> = 20A, di/dt = 100A/μs	-	55	-	ns	
Body Diode Reverse Recovery Charge	Q <sub>rr</sub>		-	101	-	nC	

Notes:

1. Repetitive rating, pulse width limited by junction temperature T<sub>J(MAX)</sub> = 150°C.
2. The EAS data shows Max. rating. The test condition is V<sub>DD</sub> = 25V, V<sub>GS</sub> = 10V, L = 0.4mH, I<sub>AS</sub> = 40A
3. The data tested by surface mounted on a 1 inch<sup>2</sup> FR-4 board with 2OZ copper, The value in any given application depends on the user's specific board design.
4. The data tested by pulsed, pulse width ≤ 300us, duty cycle ≤ 2%.
5. This value is guaranteed by design hence it is not included in the production test.



### Typical Characteristics

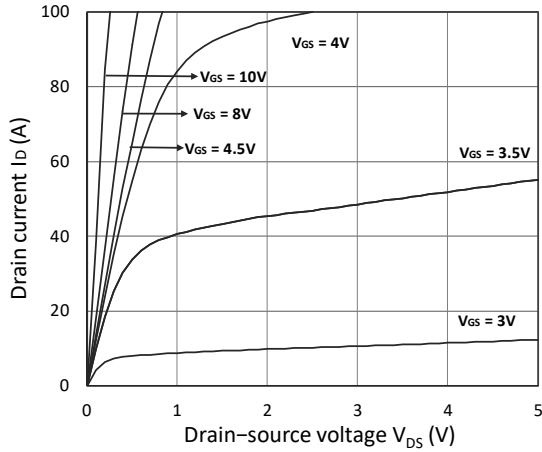

Figure 1. Output Characteristics

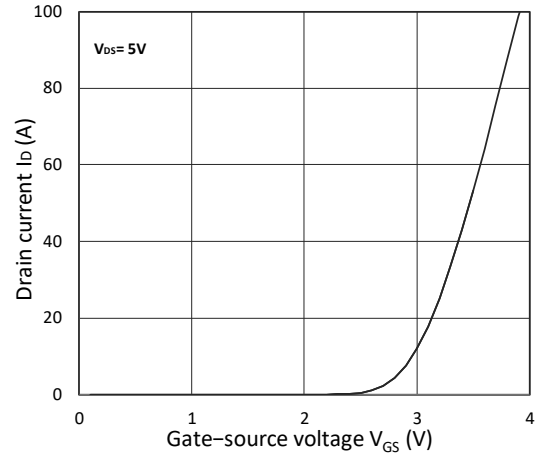

Figure 2. Transfer Characteristics

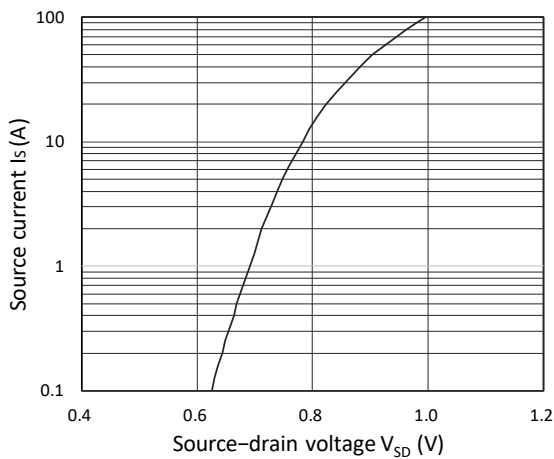

Figure 3. Forward Characteristics of Reverse

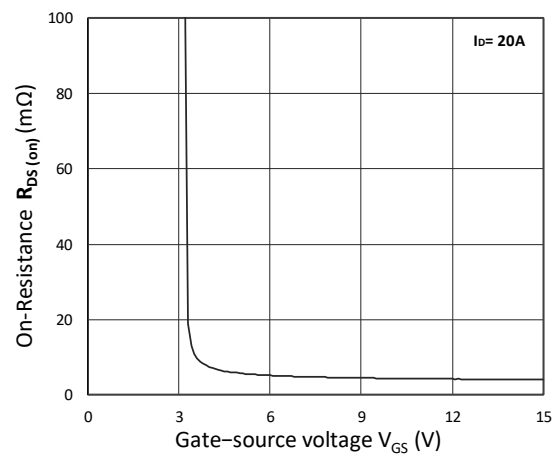

Figure 4.  $R_{DS(on)}$  vs.  $V_{GS}$

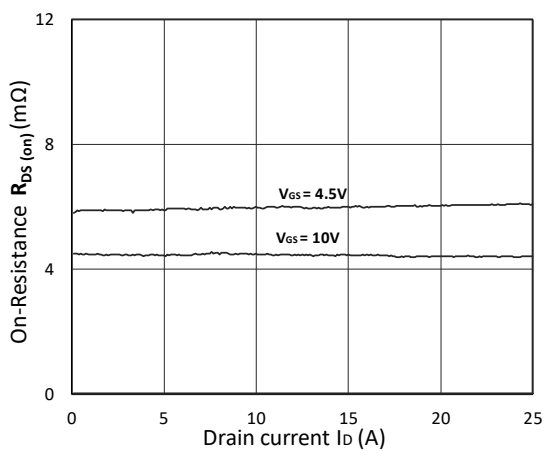

Figure 5.  $R_{DS(on)}$  vs.  $I_D$

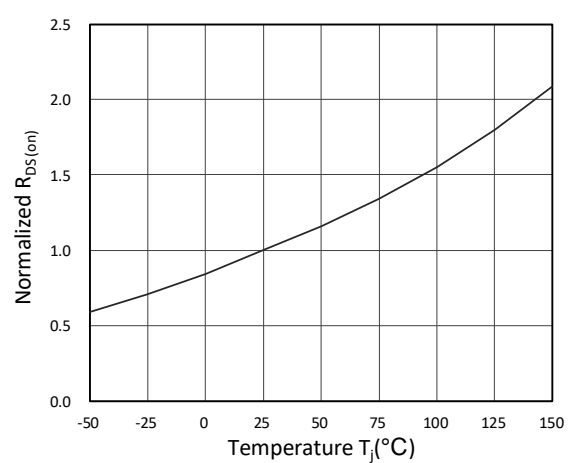

Figure 6. Normalized  $R_{DS(on)}$  vs. Temperature

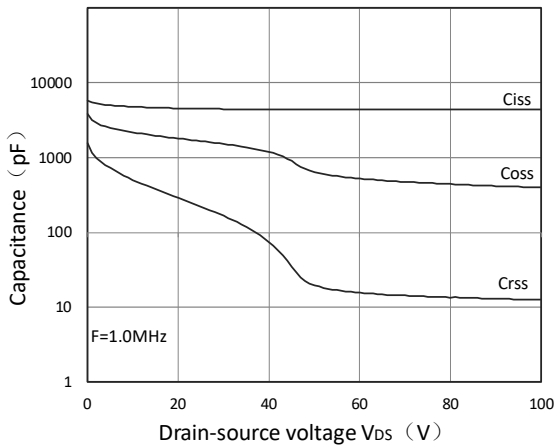

Figure 7. Capacitance Characteristics

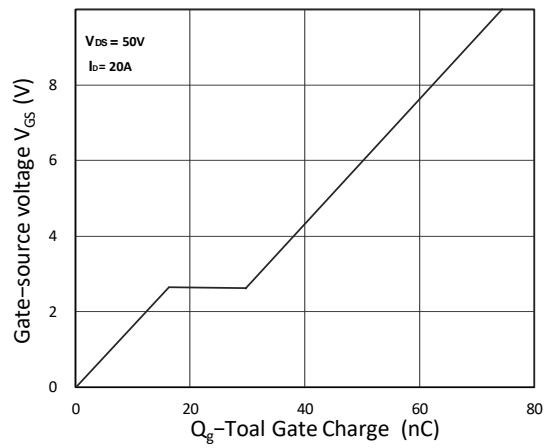

Figure 8. Gate Charge Characteristics

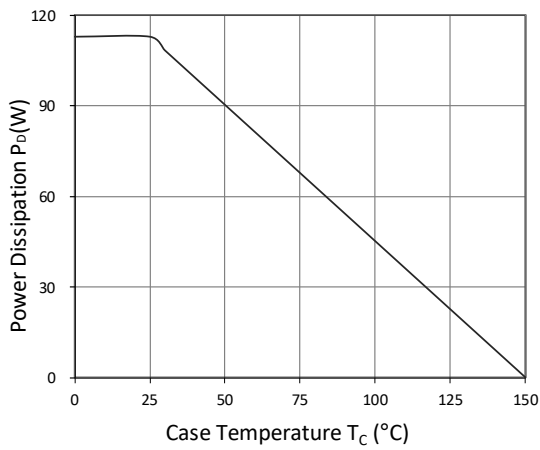

Figure 9. Power Dissipation

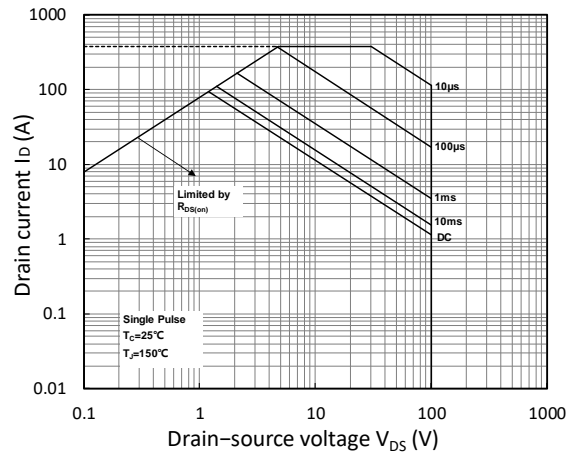

Figure 10. Safe Operating Area

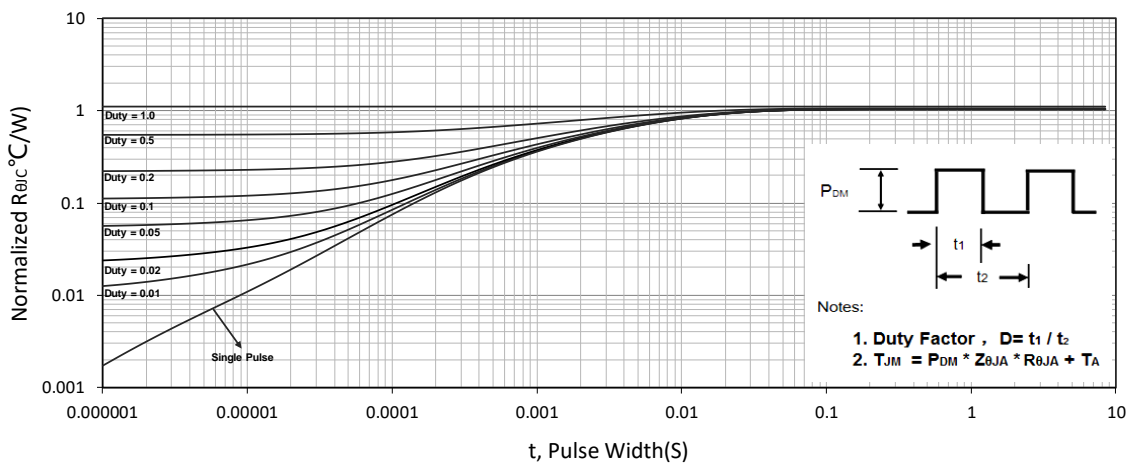

Figure 11. Normalized Maximum Transient Thermal Impedance



### ■ Test circuits and waveforms

#### Test Circuit

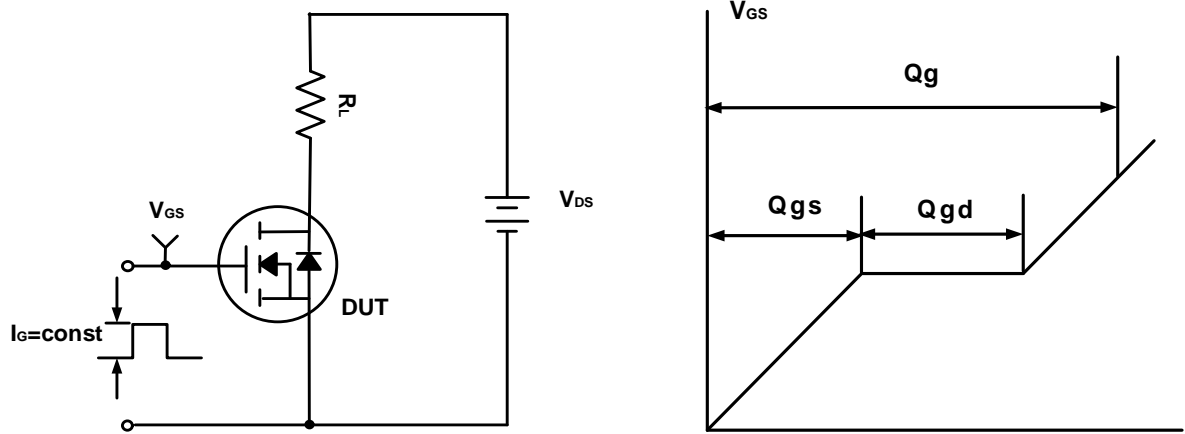

Figure A. Gate Charge Test Circuit & Waveforms

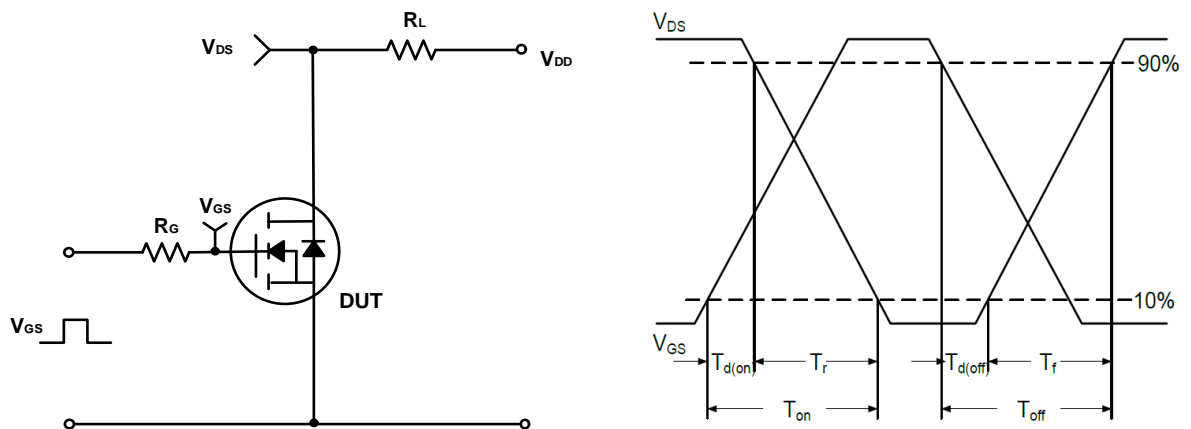

Figure B. Switching Test Circuit & Waveforms

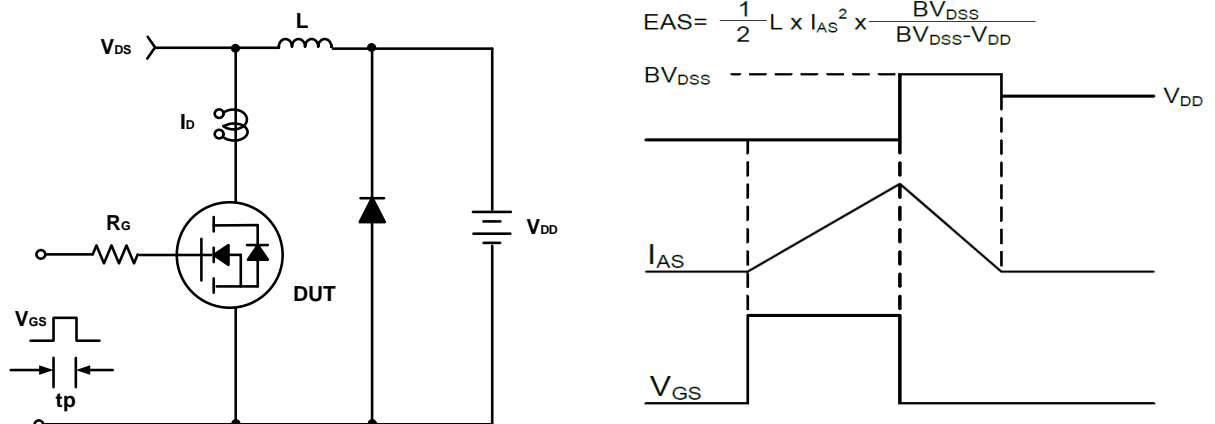
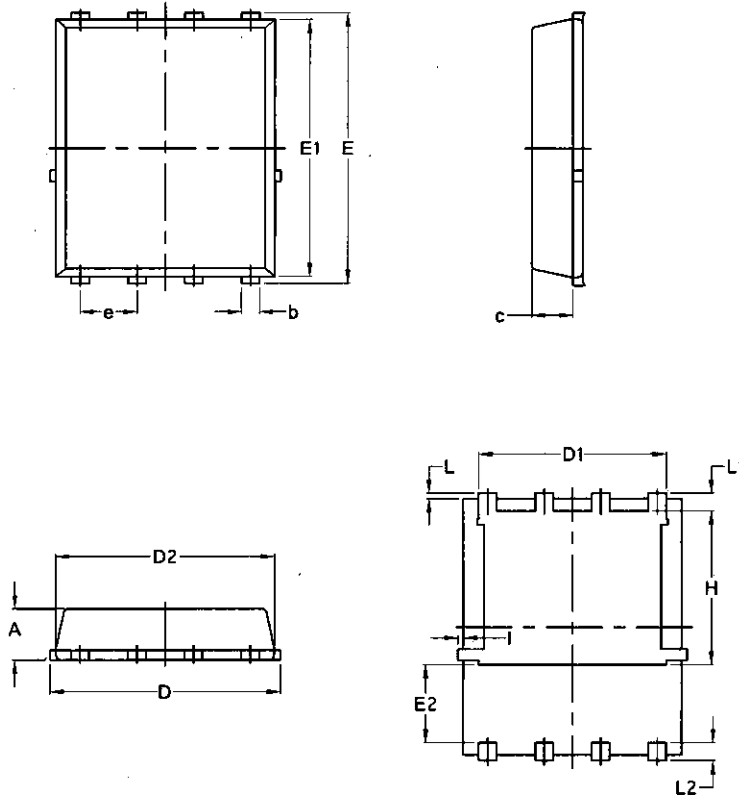

Figure C. Unclamped Inductive Switching Circuit & Waveforms



### Package Mechanical Data-PDFN5060-8L-Single



Symbol	Common			
	mm		Inch	
	Min	Max	Min	Max
A	1.03	1.17	0.0406	0.0461
b	0.34	0.48	0.0134	0.0189
c	0.824	0.0970	0.0324	0.082
D	4.80	5.40	0.1890	0.2126
D1	4.11	4.31	0.1618	0.1697
D2	4.80	5.00	0.1890	0.1969
E	5.95	6.15	0.2343	0.2421
E1	5.65	5.85	0.2224	0.2303
E2	1.60	/	0.0630	/
e	1.27 BSC		0.05 BSC	
L	0.05	0.25	0.0020	0.0098
L1	0.38	0.50	0.0150	0.0197
L2	0.38	0.50	0.0150	0.0197
H	3.30	3.50	0.1299	0.1378
I	/	0.18	/	0.0070



## **Disclaimer**

Brunei has made reasonable commercial efforts to ensure that the information given in this datasheet is correct. However, it must clearly be understood that such information is for guidance only and does not constitute any representation or form part of any offer or contract.

For documents and material available from this datasheet, Brunei does not warrant or assume any legal liability or responsibility for the accuracy, completeness, or usefulness of any information, product, technology or process disclosed hereunder.

Brunei reserves the rights to at its own discretion to make any changes or improvements to this datasheet. Unless said datasheet is incorporated into the formal contract, any customer should not rely on the information as any specification or product parameters duly committed by Brunei Customers are hereby advised to verify that the information contained herein is current and complete before the entering of any contract or acknowledgement of any purchase order. Accordingly, all products specified hereunder shall be sold subject to Brunei's terms and conditions supplied at the time of order acknowledgement. Except where agreed upon by contractual agreement, testing of all parameters of each product is not necessarily performed.

Brunei does not warrant or convey any license either expressed or implied under its patent rights, nor the rights of others. Reproduction of information contained herein shall be only permissible if such reproduction is without any modification or alteration. Reproduction of this information with any alteration is an unfair and deceptive business practice. Brunei is not responsible or liable for such altered documentation.

Resale of Brunei's products with statements different from or beyond the parameters stated by Brunei for that product or service voids all express or implied warranties for the associated Brunei's product or service and is unfair and deceptive business practice. Brunei is not responsible or liable for any such statements.

Brunei's products are not authorized for use as critical components in life support devices or systems without the express written approval of Brunei. As used herein:

1. Life support devices or systems are devices or systems which, (a) are intended for surgical implant into the body, or (b) support or sustain life, and whose failure to perform, when properly used in accordance with instructions for use provided in the labeling, can be reasonably expected to result in a significant injury to the user.
2. A critical component is any component of a life support device or system whose failure to perform can be reasonably expected to cause the failure of the life support device or system, or to affect its safety or effectiveness.